

# مارواڙي آف ب رو ڪتاب

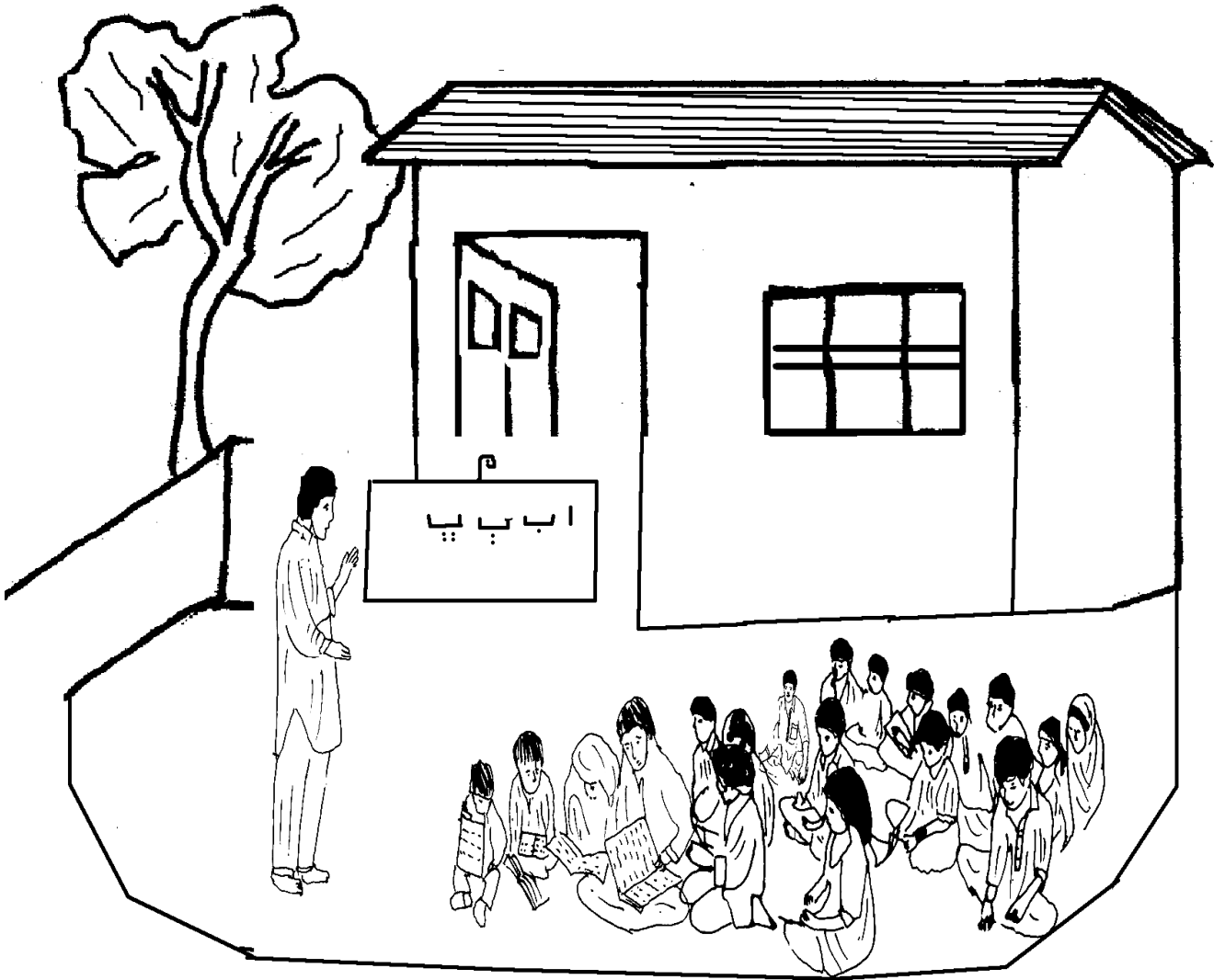

مارواڙي ٻولي را آڪر  
(الف - ب)

پ	ب	ا	آ
ٿ	ٺ	ت	ڀ
ڄھ	ڄ	ڀ	ٺ
ڌ	ڍ	ڇ	ڇ
ڙ	ر	ڍ	ڙ
ڱ	ڱا	ڻ	ڻ
ڻ	ڱھ	ڱا	ڱا
و	ڻ	ن	م
	ڻي	ء	ھ

آ



آر

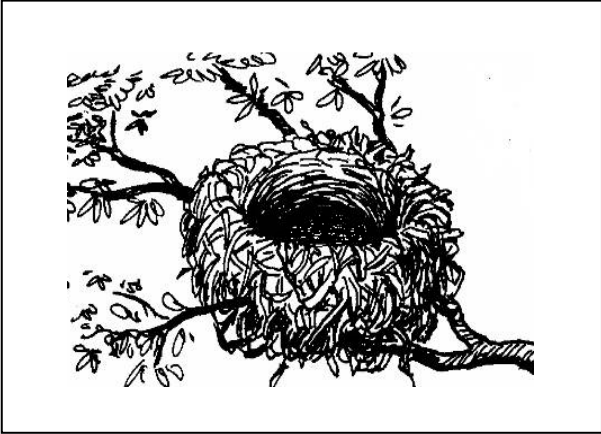

آلو



آڙمي

ا

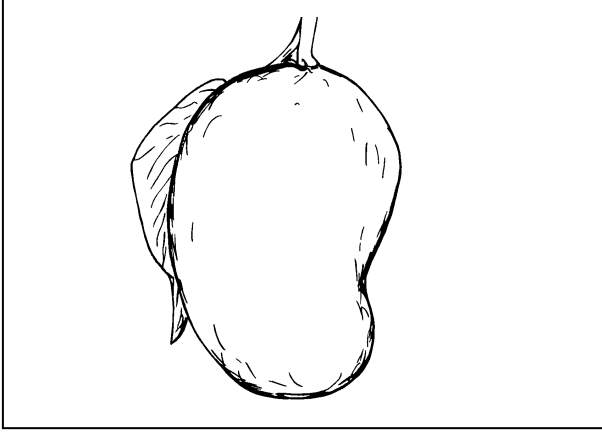

أَنْبَرِي

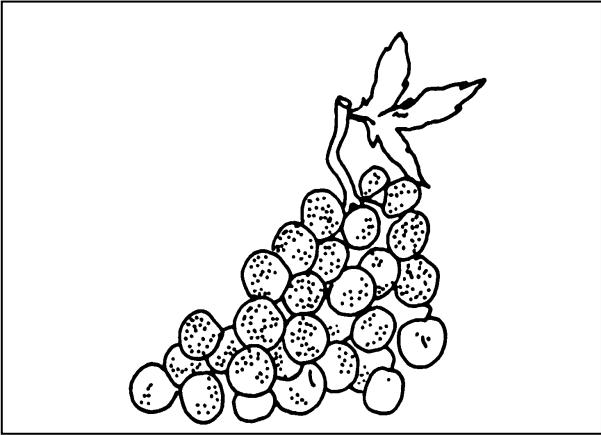

أَنْگُور

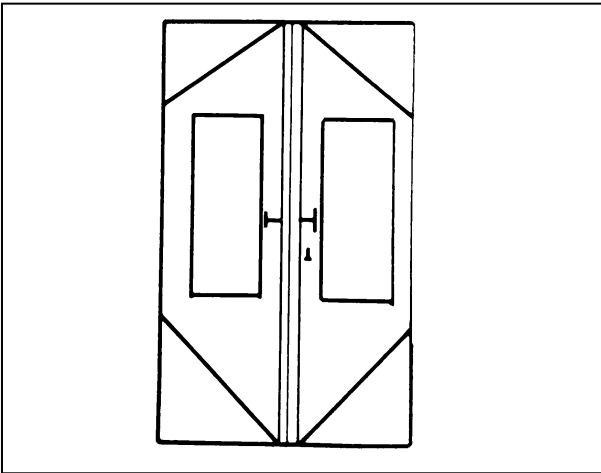

أَلْمَالِي

ب

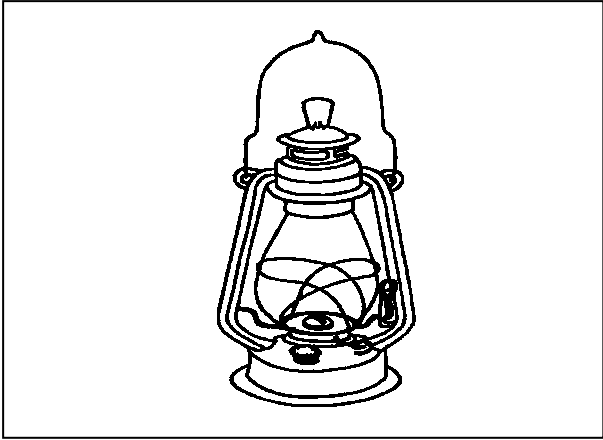

بَتِي

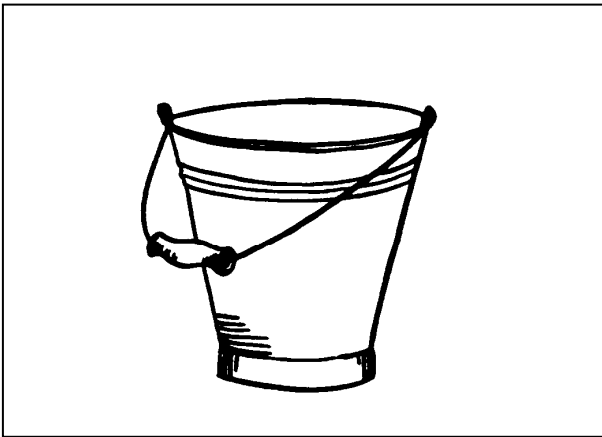

بالتِي

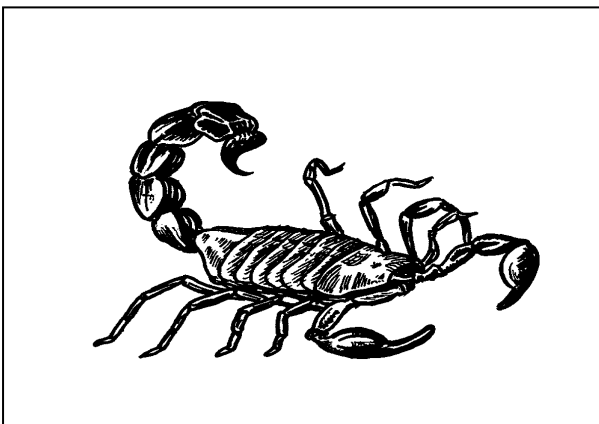

بِجُو

پ

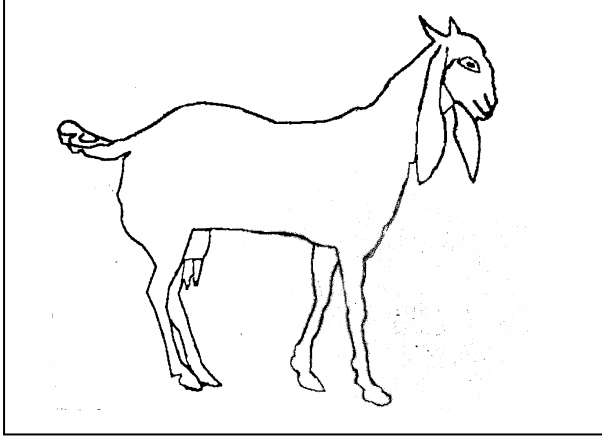

پَکَری

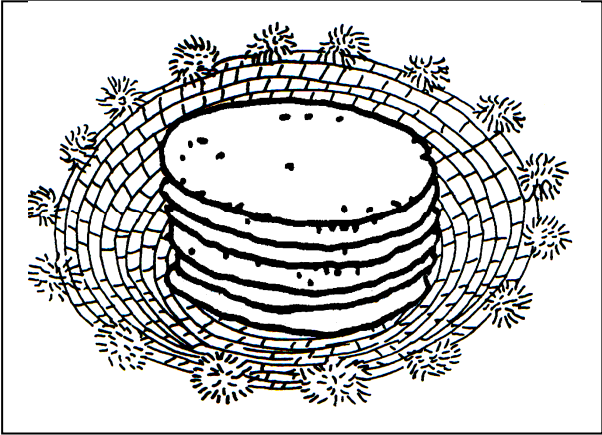

پاٲی

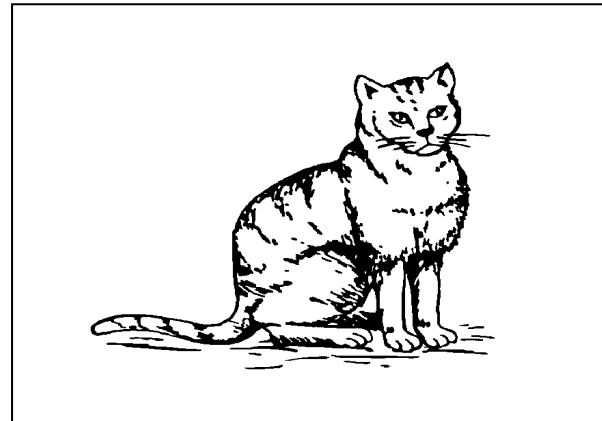

پلی

پ



پگت

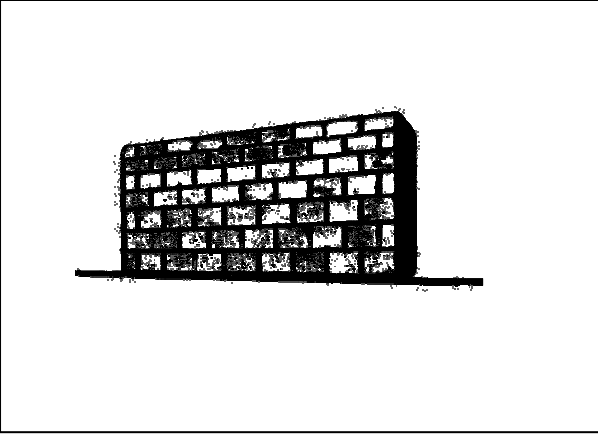

پنت

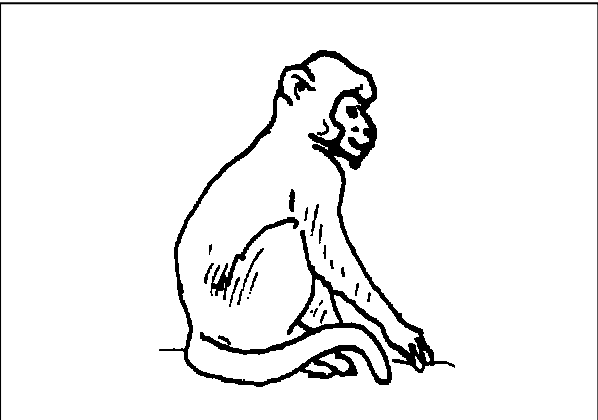

پولٹو

ت

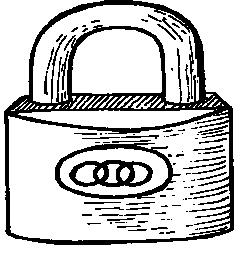

تالو

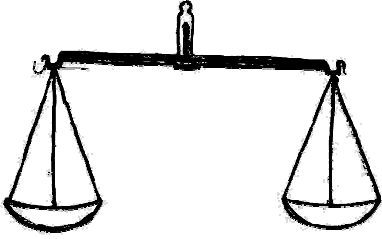

تاكلِي

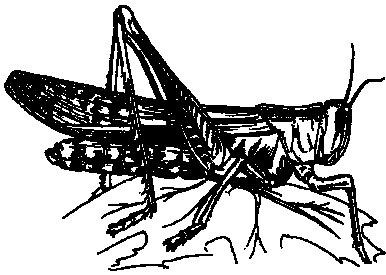

تِيْد



ت

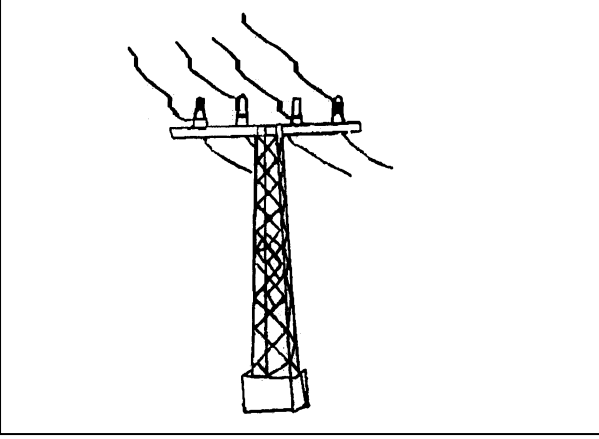

تَنِيو

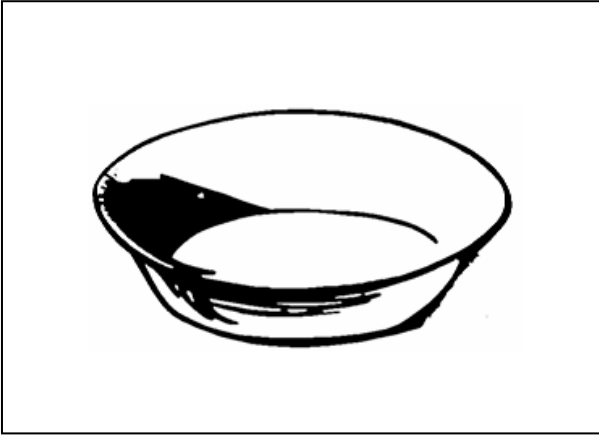

تال

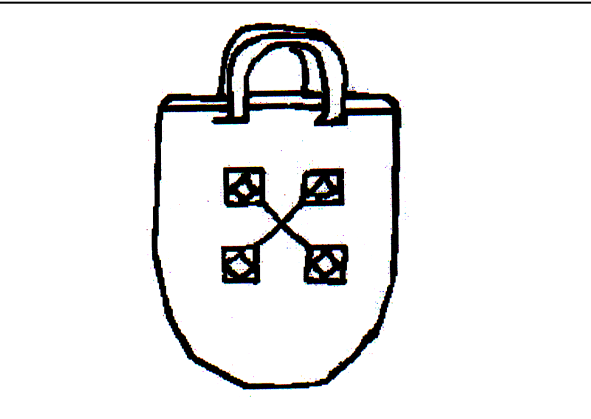

تيلو

ت



توپي



ٲيلوٲي

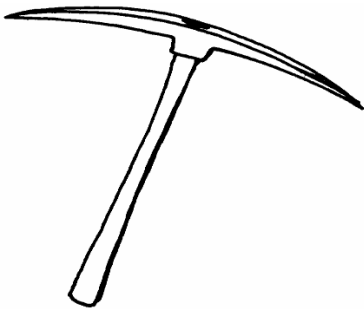

ٲيڪم

ن



نِیْگَر

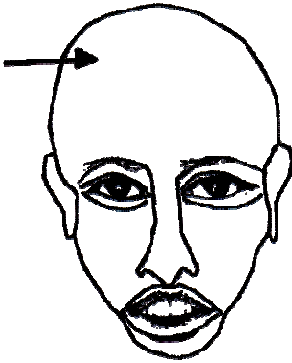

نُوژھُو



نُونُ

پ

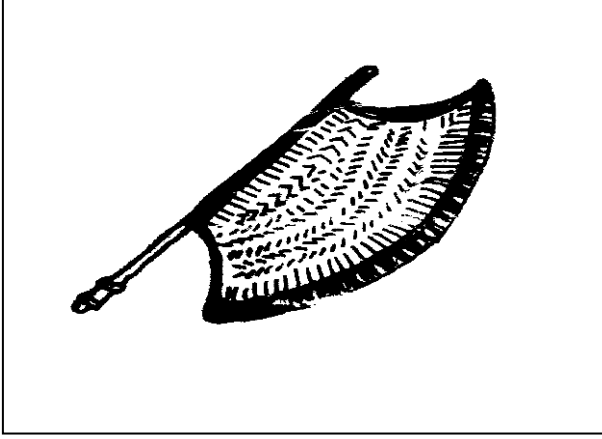

پکیو

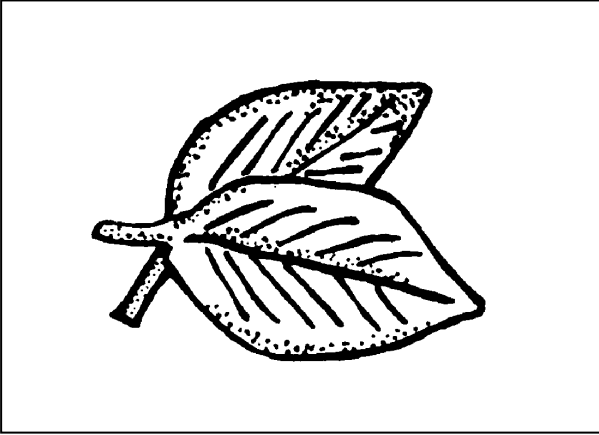

پون

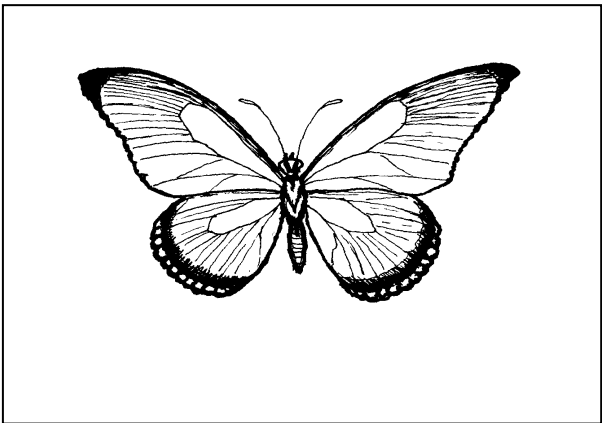

پوٲت

ج



جَگ

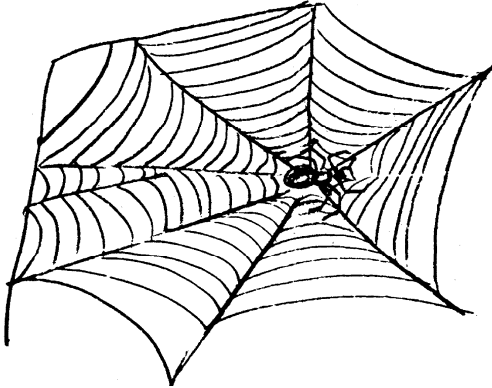

جال

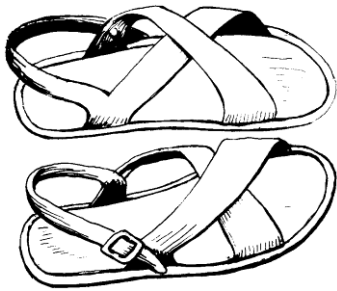

جُتي

جہ

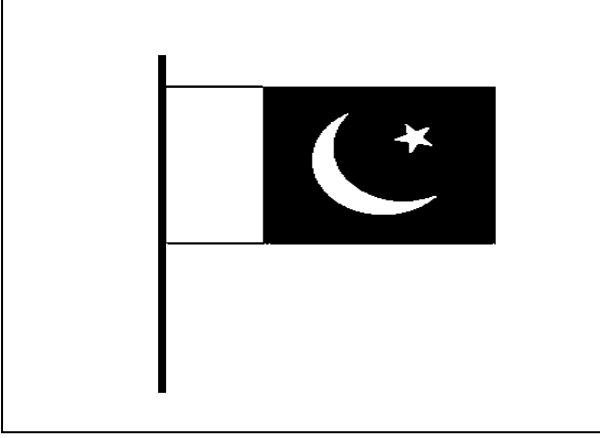

جہندو

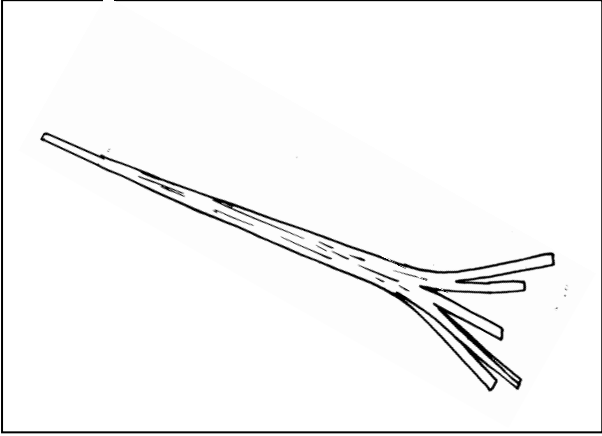

جھیرٹو

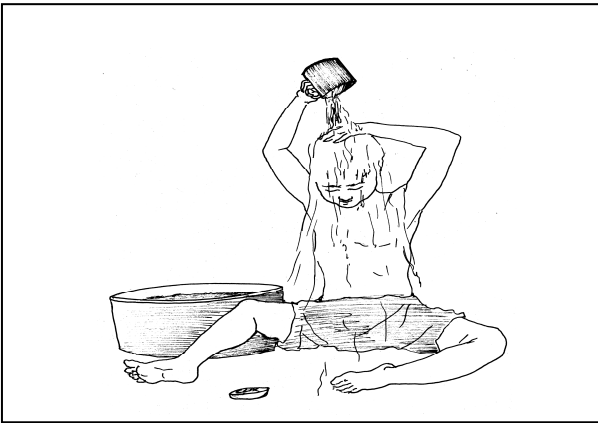

جھیلٹ

چ

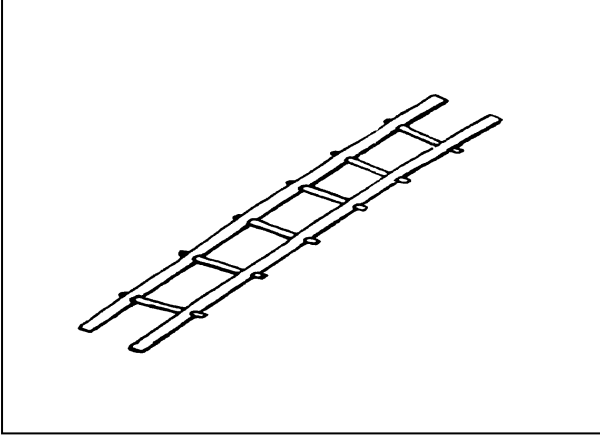

چاڑھي

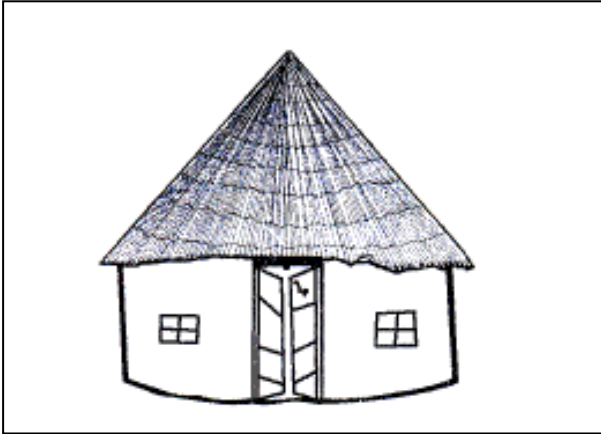

چونرو

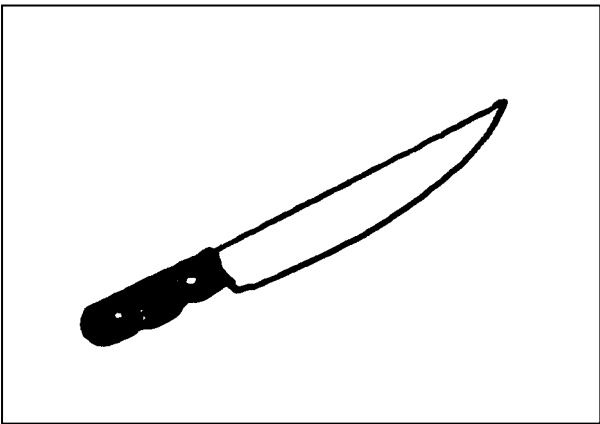

چاڪو

چ

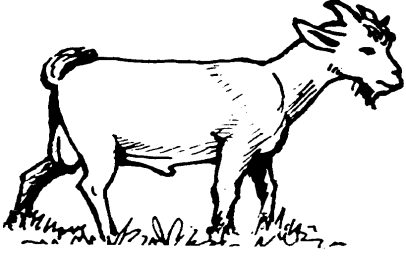

چیلو

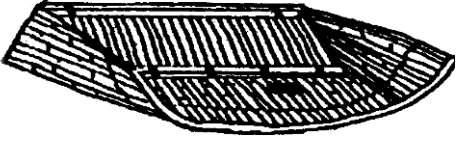

چا جٲرو

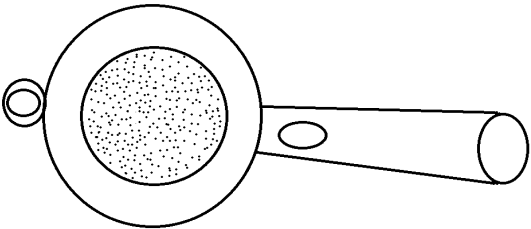

چورٲي



د

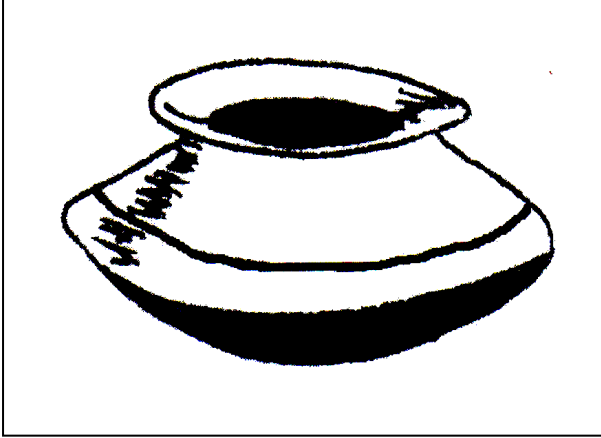

دیگ

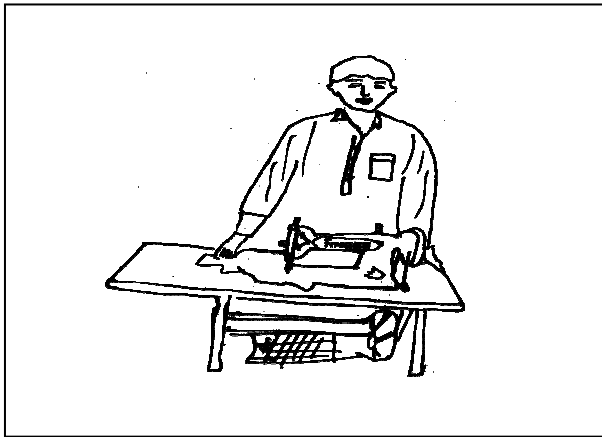

دَرزِي

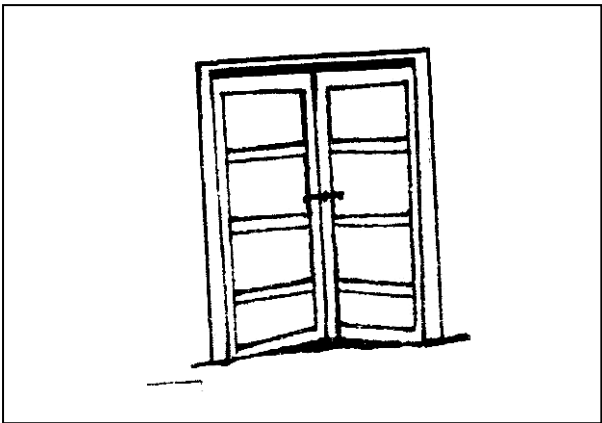

دَر

ت

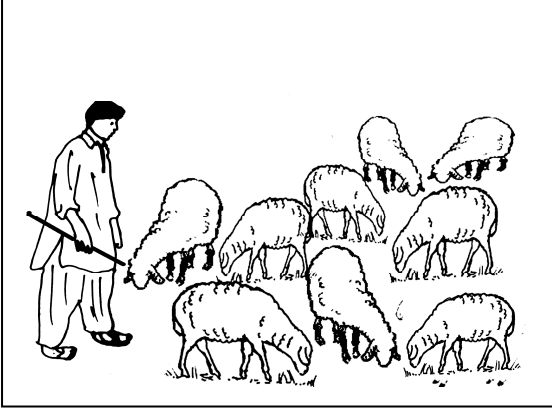

تَرَات

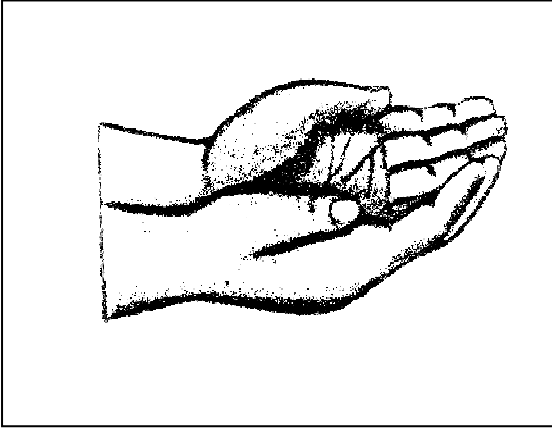

تَوْبُو

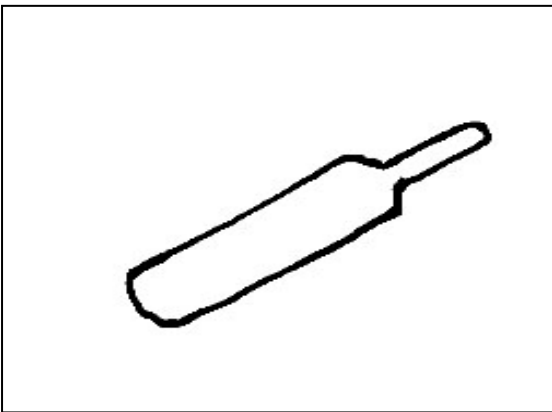

تُكِي

تا

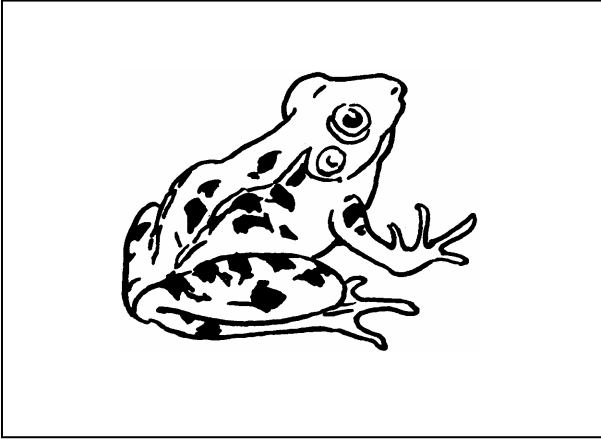

تَيدَر

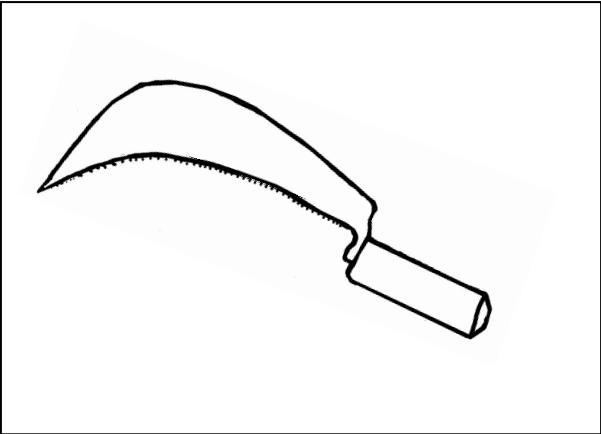

ذاترو

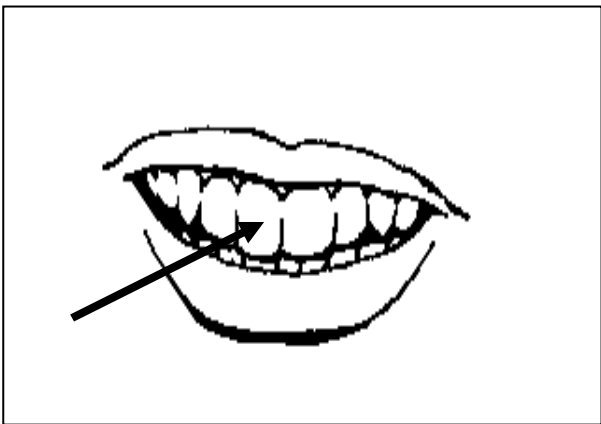

ذونت

پ

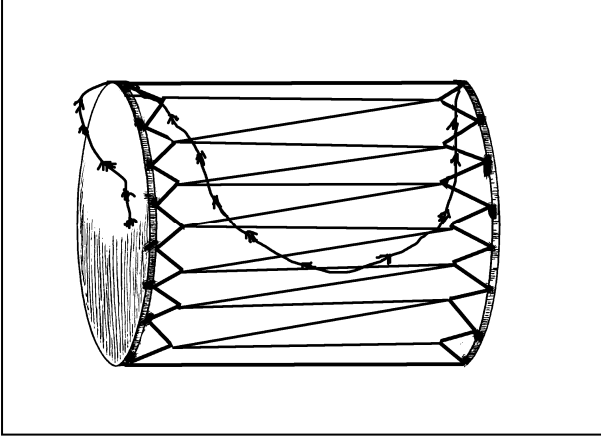

دیول

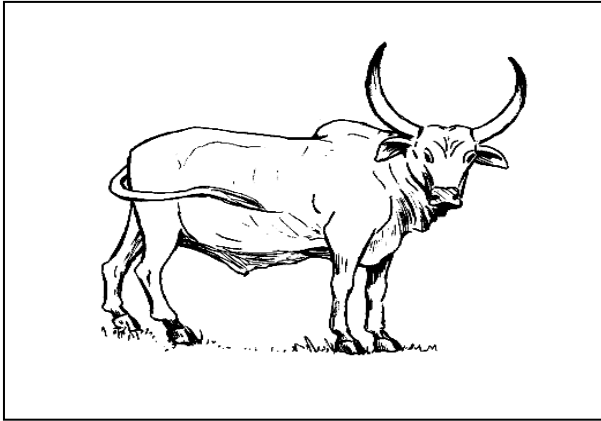

دیگو

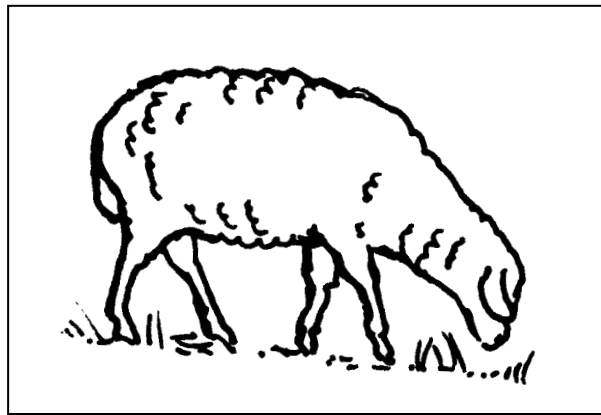

پ

ر

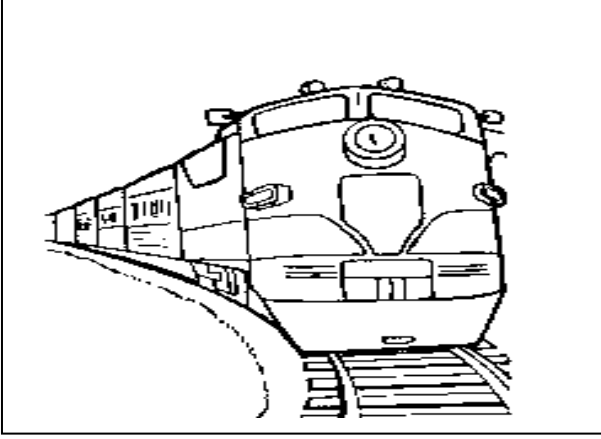

ريل گاڏي

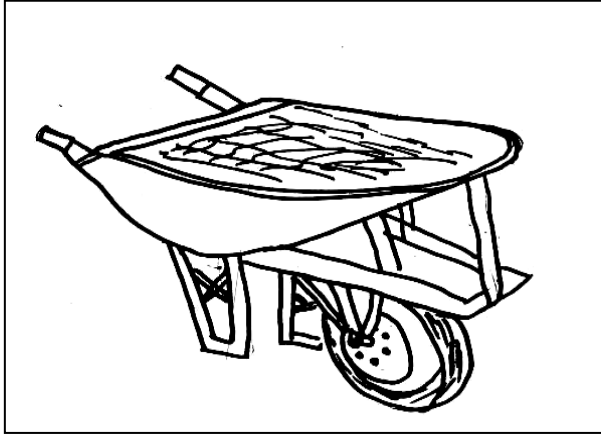

ريڙهي

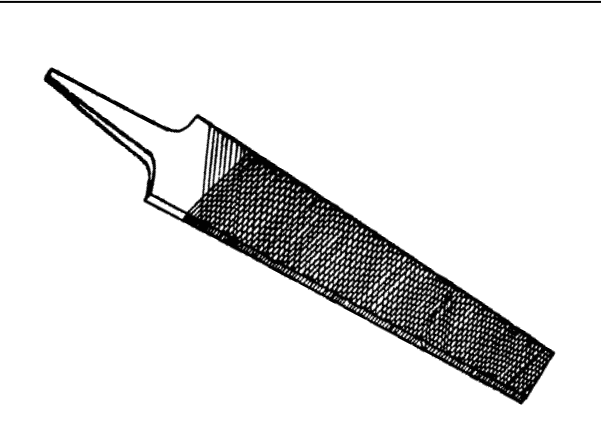

رَوَات

ز

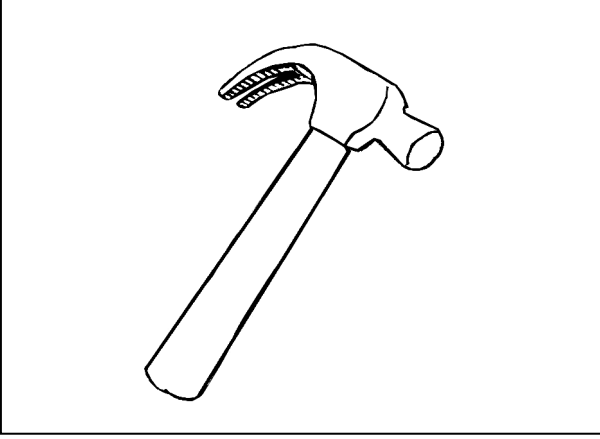

هَتَوَرِي

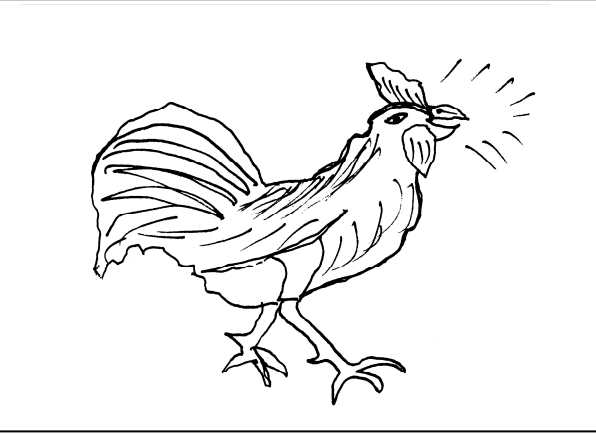

كُكْرُو

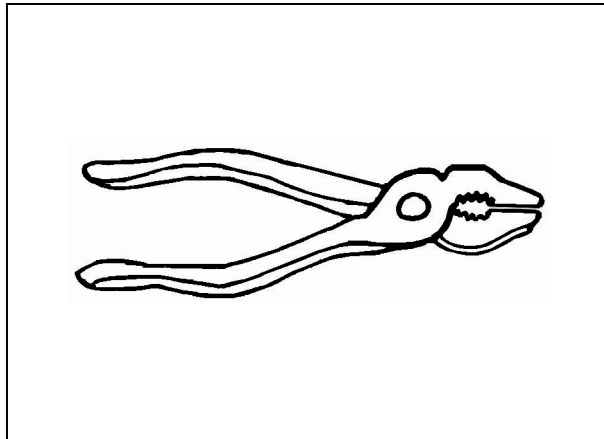

پَكْر

ل



پال

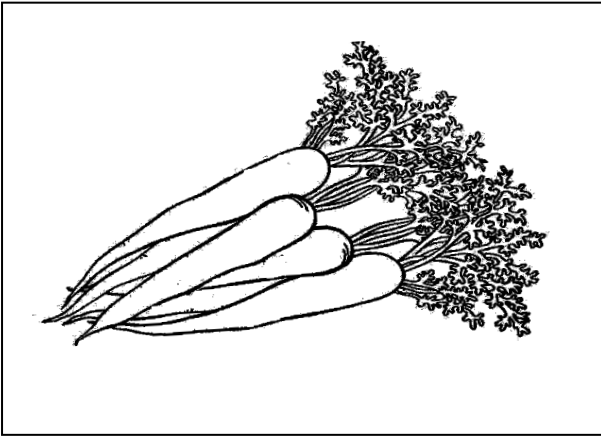

مُولِي



هالي

س

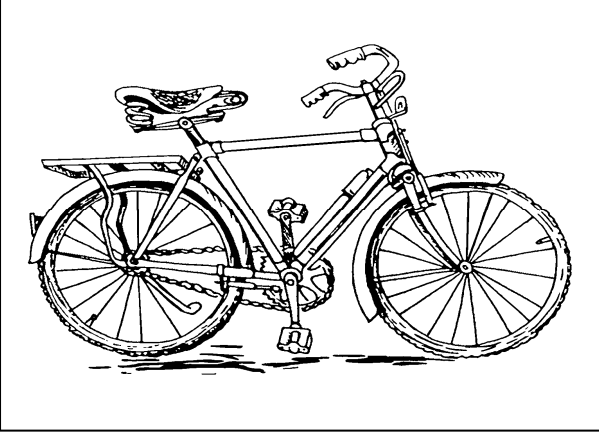

سِينَكَل

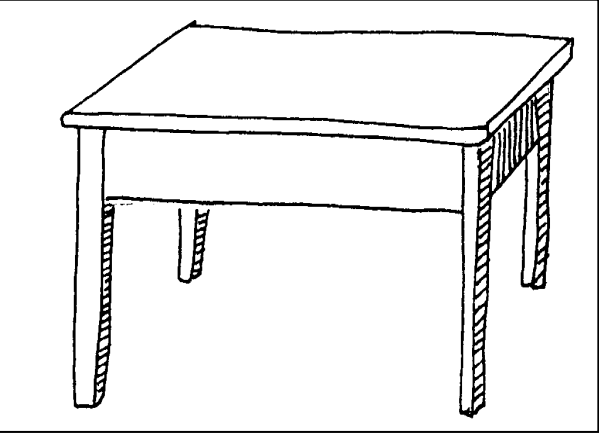

سَنَدَل

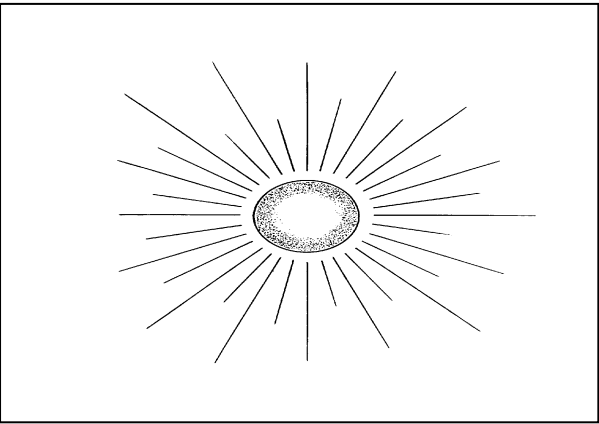

سُورَج



ق

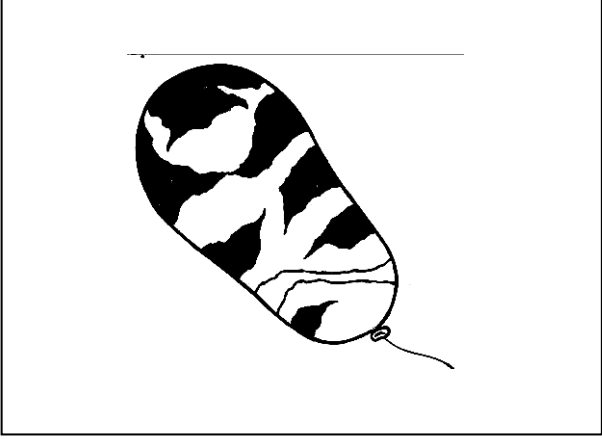

قُوَكَطُو

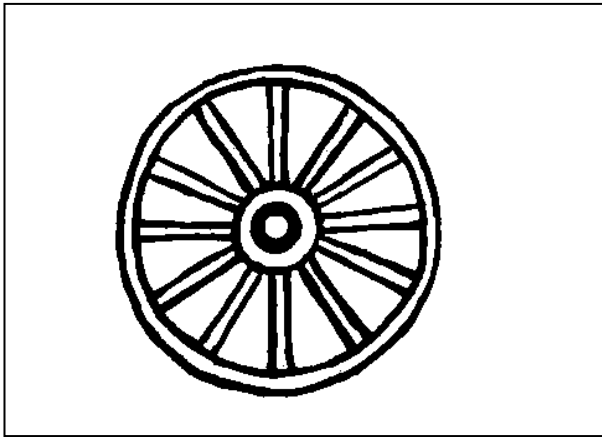

قِيَتُو

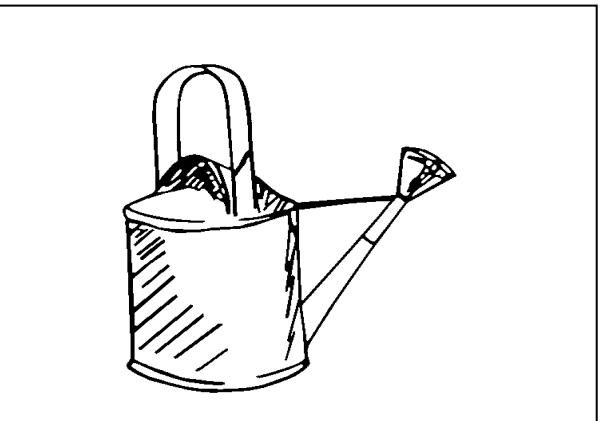

قُوَهَارُو

ڪ

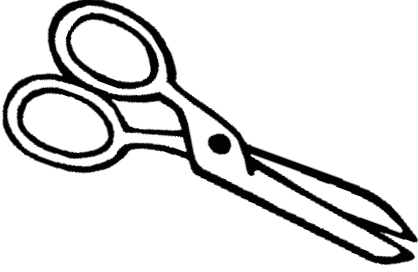

ڪَڙِٽِي

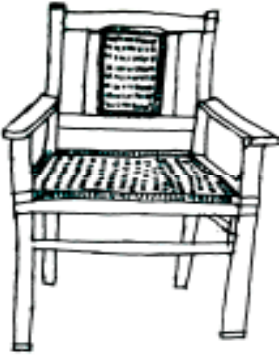

ڪُڙِي

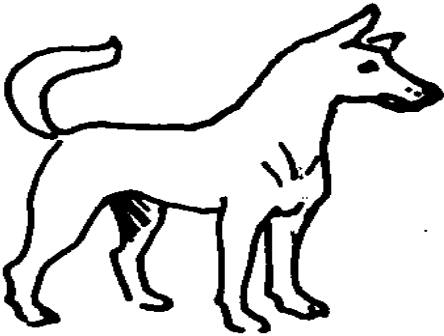

ڪُٽو

ک

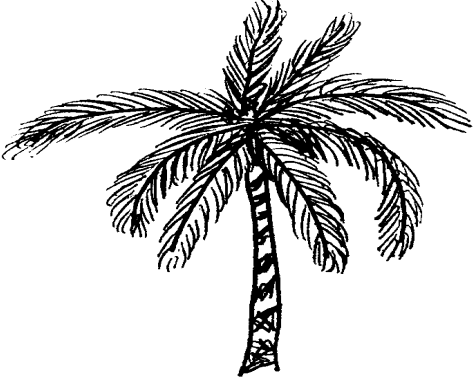

کجی

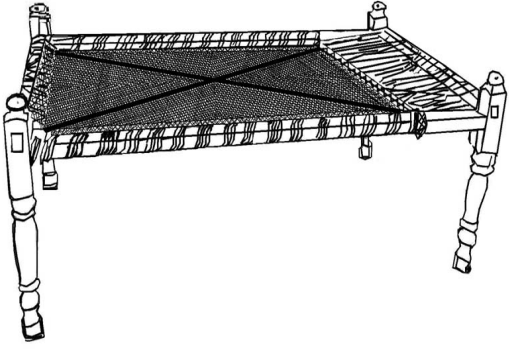

کات

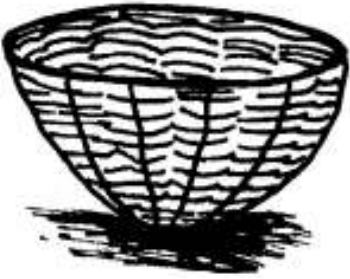

کاریٹو

گ

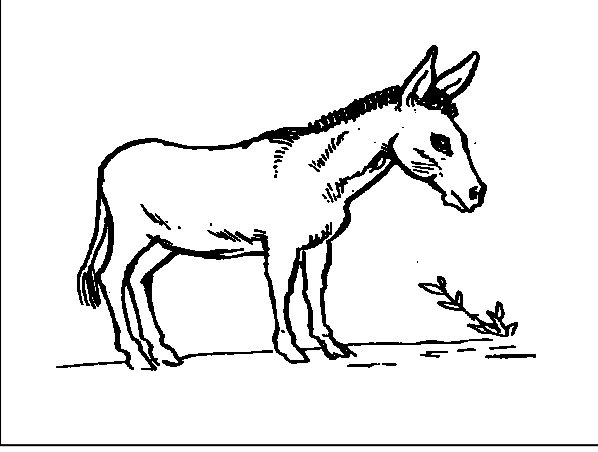

گڈو

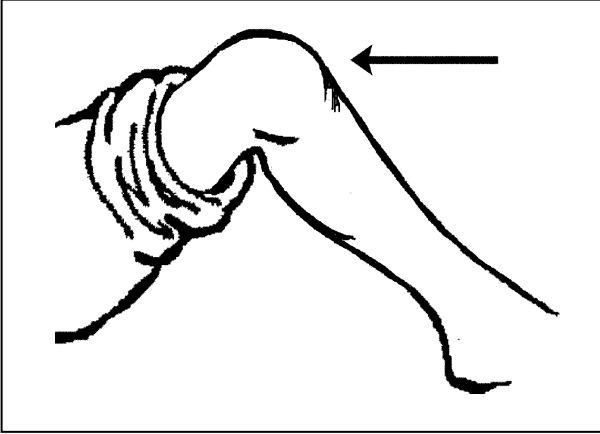

گوڈو

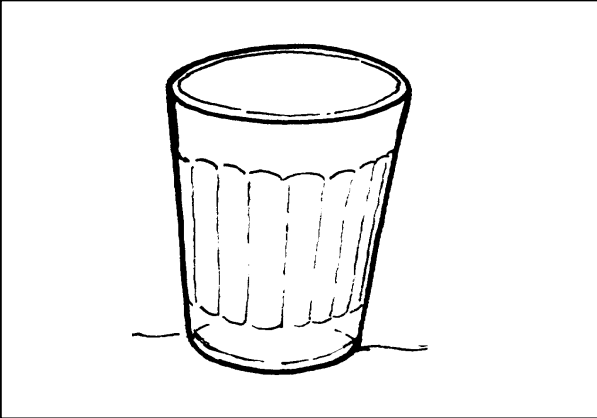

گلاس

گه

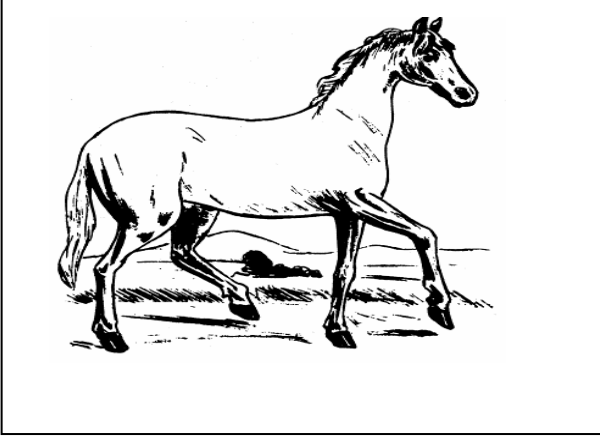

گهوڙو

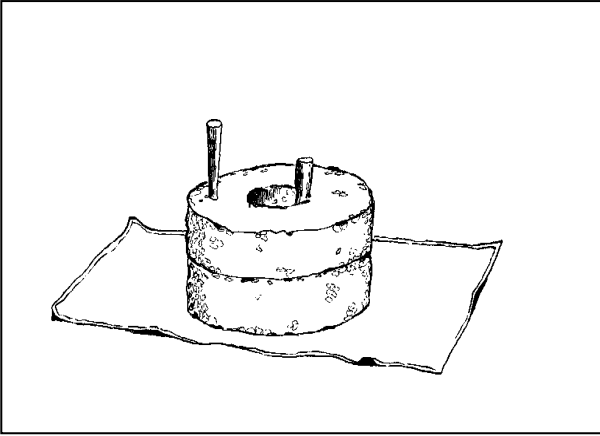

گهڙي

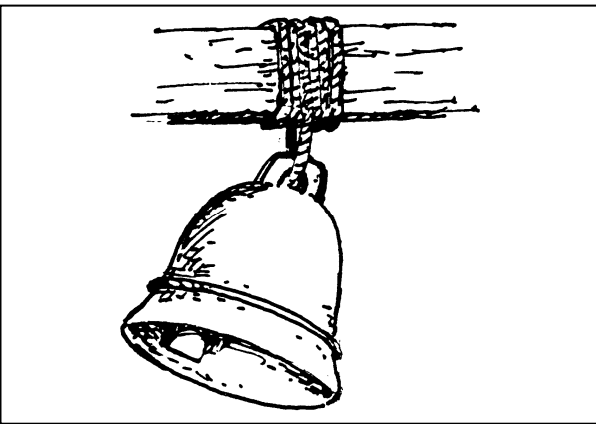

گهڙي

ل

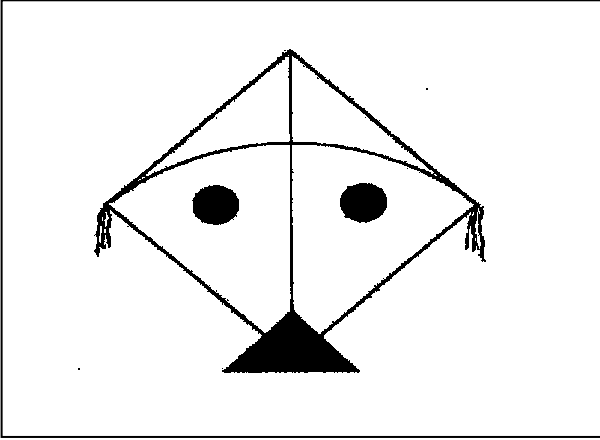

لڳڙو

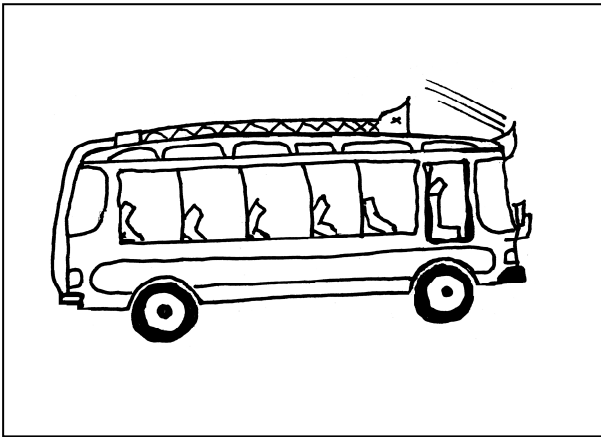

لاري

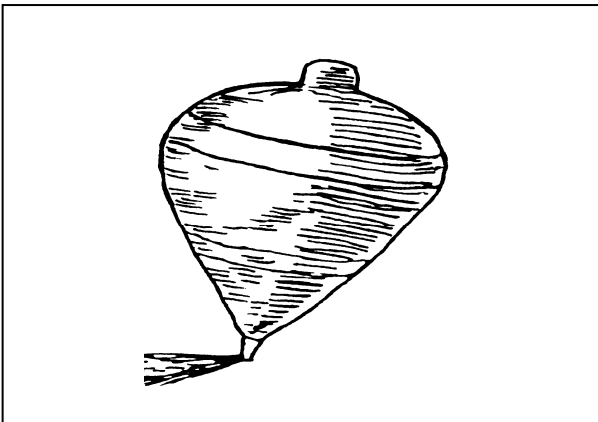

لاٽو

م

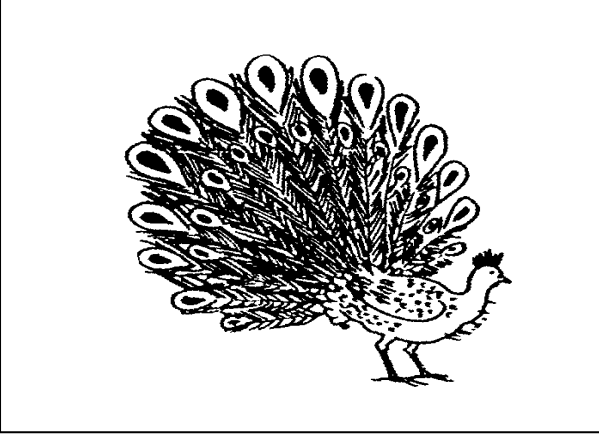

مورِيئو

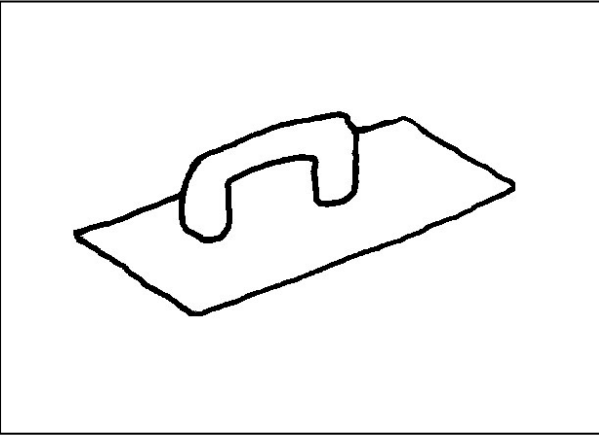

مارو

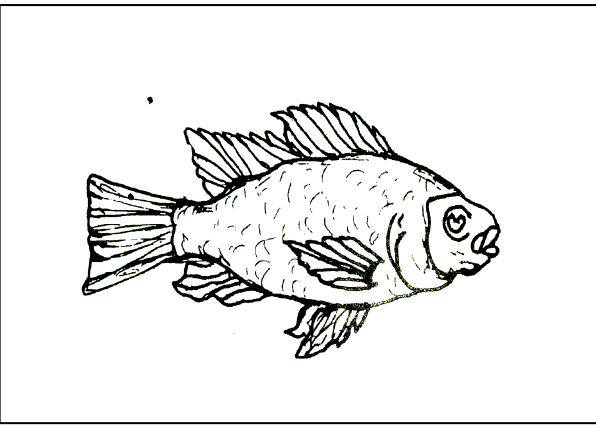

مَچِي

ن

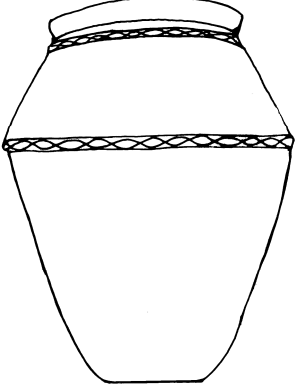

نَادِي

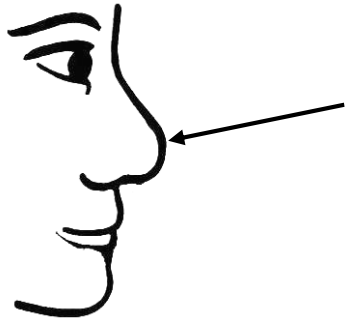

نَاك

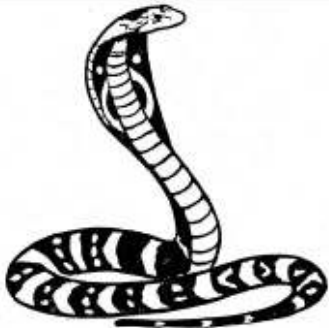

نَانِگ



ط



بَط



رَوِئَط

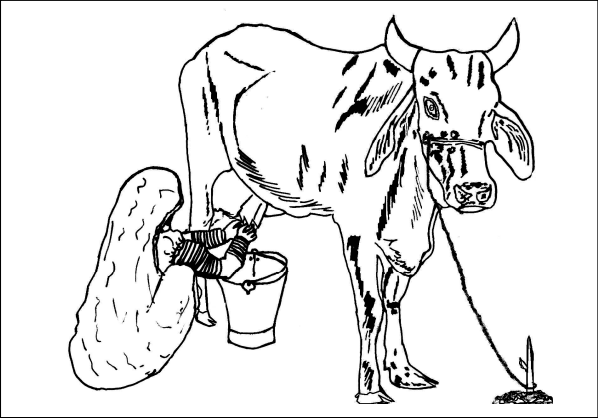

ذَوِئَط

و



واڊو

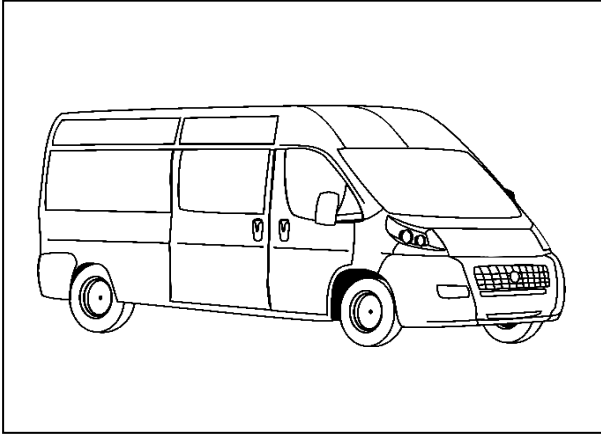

ويگن

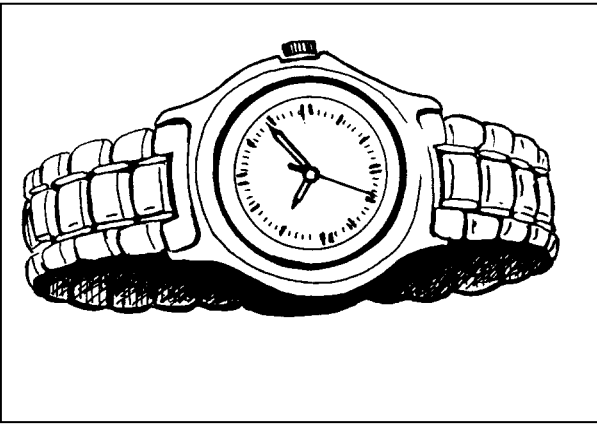

وانچ

ہ

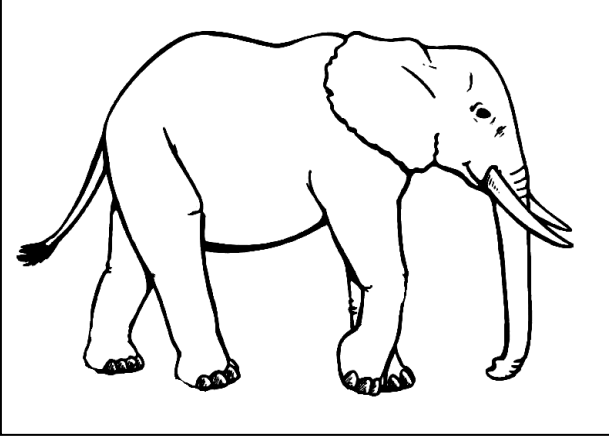

ہاٹی

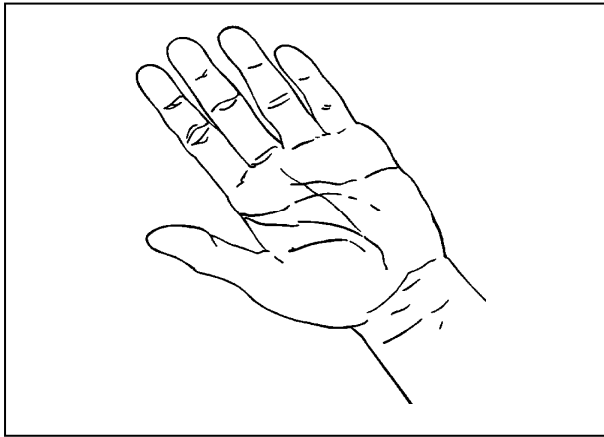

ہات

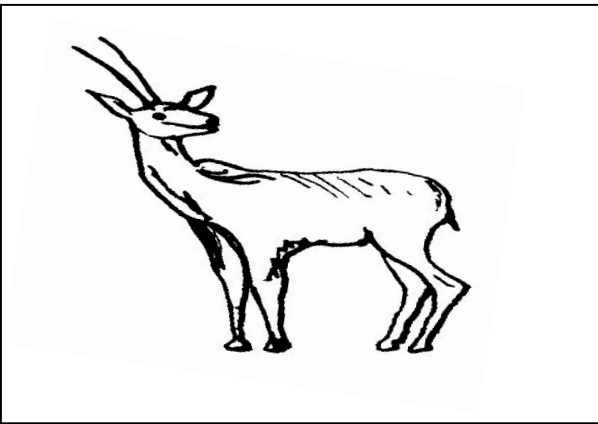

ہرّط

۴



لُگائي

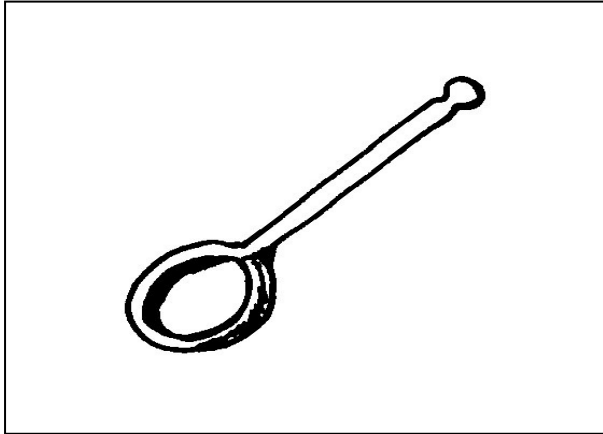

ذوئي

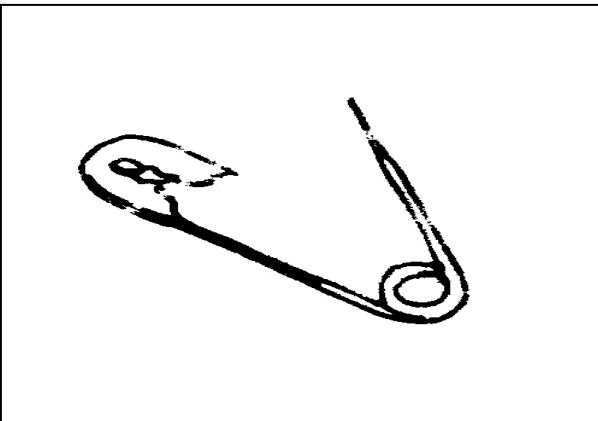

سُئي

ي

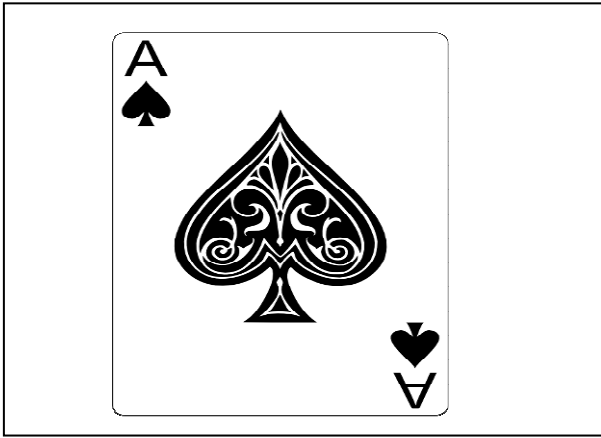

يَكُو

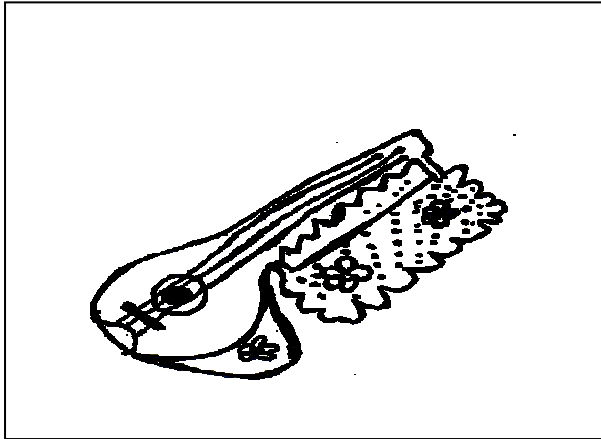

يَكْتَارُو

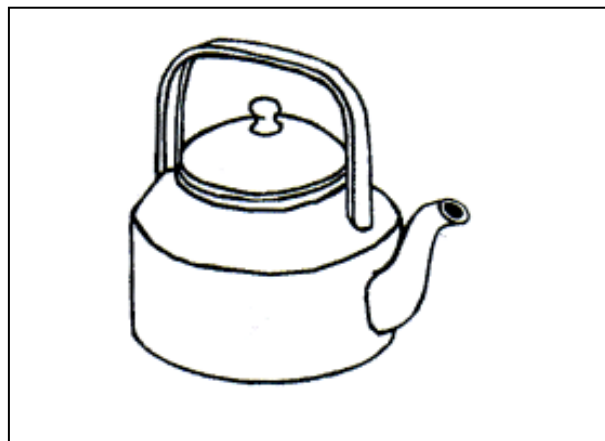

كِتْلِي